

JUMBO JUMBO COMBILINE

PÖTTINGER High performance silage wagon with loading rotor





JUMBO

PÖTTINGER

JUMBO 6610
powermatic+

autocut

High performance with excellent cost effectiveness

The PÖTTINGER product range includes a total of 16 different JUMBO and JUMBO COMBILINE models for tractors between 160 and 450 hp.

JUMBO – Silage wagon

High performance silage wagons fulfil all the requirements for efficiency and cost-effectiveness, confirming their role as the harvesting process of the future: fewer operators, reduced diesel consumption and straightforward logistics.

JUMBO COMBILINE – 2 in 1 loader wagon technology – the silage/harvesting combination

Maximum versatility and increased machine utilization are guaranteed as a result. In combination with its high performance, the PÖTTINGER JUMBO COMBILINE loader wagon offers excellent economy, strengthening still further the significance of the self-loading wagon system as the harvesting process for the future.

Contents

	Page
Frame / Bodywork / Hitch	4
Driveline / Power transmission	6
Pick-up / Loading rotor / Chopping system	8
JUMBO COMBILINE – multifunctional	18
Automatic loading / unloading	20
Chassis / Tyres	24
Control system	30
Technical data / Equipment	32

All information on technical data, dimensions, weights, output, etc. is approximate and is not binding.

Impressive construction



Easy hitch

A turning angle up to 60° is possible, even with steered axles, depending on tractor and tyres thanks to the narrow design of drawbar. All hoses and cables are routed tidily through the hose holder. The hinged drawbar is equipped with shock absorbers and automatically moves into the transport position at the press of a button.

The drawbar

Choose between 4409 lbs / 2.0 t, 3313 lbs / 3.0 t or 8818 lbs / 4,0 t supported load (depending on country).



Hydraulic steered axles

System complies with DIN ISO 26402 and guarantees wagon follows in tractor's tracks on slopes and in the clamp.

- Compact, fail-safe design.
- Steering linkage with automatic interlock for single-handed attachment.



Electro-hydraulic steered axles

For high level of stability when travelling at high speeds and the best manoeuvrability in tight corners is ensured by the speed-dependent steering angle adjustment system. Tandem and tridem axles are only controlled from one side. Load sensing, air brakes and 26.5" tyres are required.

- Lowest tyre wear
- Easy hitching
- Compact design without mechanical components
- Axles can be locked from the terminal at the press of a button



Strength with the highest quality

The rugged frame construction is made using high quality QSTE fine-grained steel. Frame and side pillars are fastened using finely threaded bolts – no welds. High-strength side profiles and closely spaced pillars ensure the highest strength.

- Clear inside width of 7.54" / 2.30 m.
- Tailgate opening angle can be adjusted as required from the tractor seat.
- Enter the wagon's loading chamber using a convenient access ladder.
- Floodlights mounted on the front panel provide excellent illumination of the loading chamber.



Optional equipment:

- Large tailgate with extension boards for an additional 52.96 cubic foot/ 1.5 m³ load capacity for JUMBO L models (not COMBILINE)
- Roof profiles for JUMBO models improve compression of hay and straw. (Standard on JUMBO 10010).
- LED floodlights on front panel and mudguards.
- Video system with monitor and one or two cameras.



Power transfer up to 2500 Nm



20% higher performance

The driveline is engineered for high performance and is what characterises the JUMBO loader wagon from PÖTTINGER. These silage wagons are designed for tractors up to 450 hp.

They are driven by a PTO shaft with wide-angled joints at both ends and a cam-type clutch to protect the driveline. The large-dimensioned rotor transmission, which is submerged in grease, is completely maintenance-free.

- The driveline is protected at an impressive torque of 2500 Nm, corresponding to a peak performance of 331 kW / 450 hp.
- This means a 20% increase in performance compared to older models.
- Easy fitting thanks to automatic coupler.



Scraper floor drive system

The scraper floor gearboxes are centrally located. Hydraulic motors with single or two-speed ratios deliver a maximum unloading speed of up to 78"/ 24 metres per minute. The scraper floor is equipped with four or six chains, depending on the model.



Beater drive system

The driveline to the beater rotors is concealed within the frame. The strong drive shaft is protected by a cam clutch at 1500 Nm.

High performance pick-up

with eight rows of tines



Freely-suspended pick-up for ensures maximised intake.

The PÖTTINGER pick-up guarantees maximum feed rate. The transfer zone from the pickup tines to the rotor has been optimised and adapted to high throughput. The PÖTTINGER suspended pick-up with eight rows of tines delivers impressive performance – even at high travelling speeds and in difficult harvest conditions – for reliable and high pick-up performance.

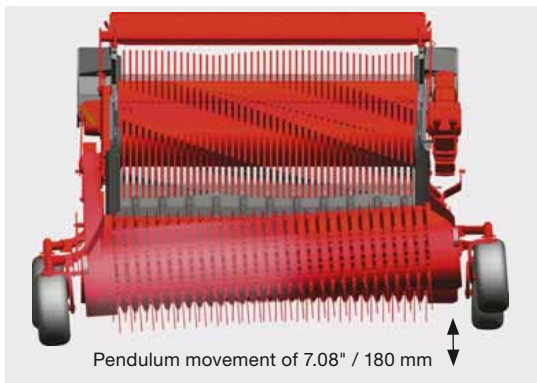

Two jointed support arms ensure the pickup has complete freedom of movement. A spring alleviates the pickup weight so less pressure is exerted on the ground. Height-adjustable 16 x 6.5-8 trailed jockey wheels contact the ground on precisely the same line as the tines to ensure perfect ground tracking and cornering.

- Unique travel of 7.08" / 180 mm for perfect ground tracking and exact contouring
- Automatic pick-up switching on all JUMBO models.





Controlled pick-up for clean forage

The pickup is controlled from both ends by a steel cam track. The sealed twin-race roller bearings on the cam rollers are designed to withstand high stress.

The pick-up tines are controlled in a sweeping arc. This guarantees optimum protection of the sward, lower levels of soil and prevents unnecessary wear to the tines. A large swath roller ensures perfect crop flow at high loading speed.

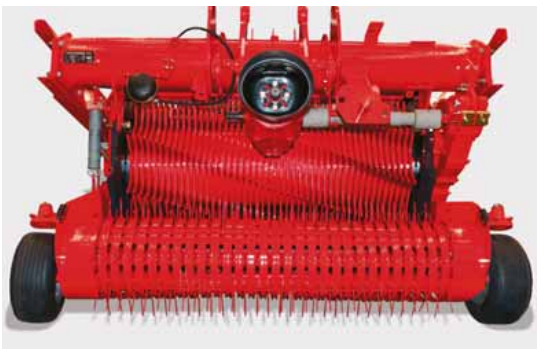

Convincing arguments

Clean forage

thanks to controlled speed and tine movement. The tines are slightly trailed to sweep in a controlled arc and adapt ideally to contours.

Perfect transfer

to the rotor in all conditions. Fully active tine length up to control point.

Improved chopping quality

because forage is not 'combed through'; less longitudinal alignment of stalks.

Easy maintenance

The cam track only needs to be lubricated once per year. The main bearings have a lubrication interval of 80 loads and are easily accessible from outside.

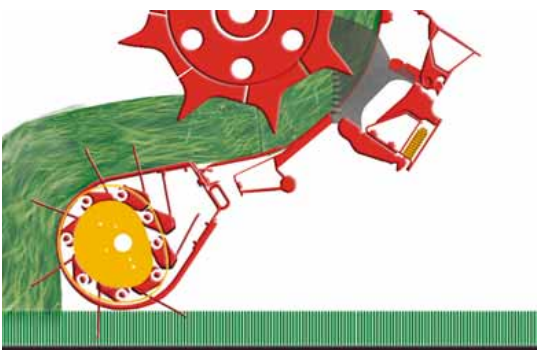



New add-on support roller behind the pick-up

This newly-developed additional support roller is located behind the middle of the pick-up on PÖTTINGER loader wagons. Being located in the centre prevents it from sinking into tractor wheel marks and as a result guarantees perfect ground tracking. The outer width is 8.59" / 2.62 m.



Unique parallelogram guidance

The parallelogram guide linkage ensures significantly improved contour tracking for clean forage, even in difficult conditions. 100% freedom of movement of the pick-up is ensured. Adjustment is independent for the front jockey wheels.

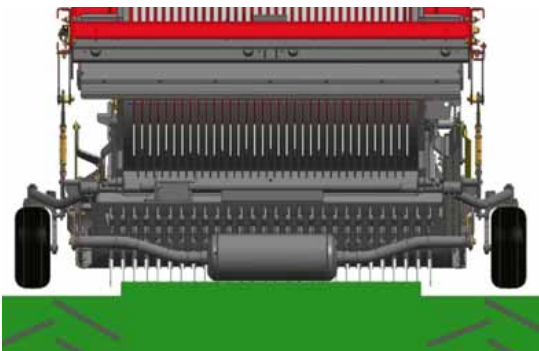



SUPERLARGE 7.74" / 2.36 m pick-up

Highest pick-up performance with a working width of 7.74" / 2.36 m. Very wide swaths can be picked-up tidily. Driving into the swath and cornering are also much easier and take the pressure off the driver.

Hydraulic folding jockey wheels

These jockey wheels are located outside the tractor's tracks to provide optimum ground tracking. The jockey wheels are folded in hydraulically from the operator terminal. As a result the transport width is reduced to 8.36" / 2.55 m.

Swath merging in the pick-up

Feed augers on both sides merge the swaths. The swath is evenly distributed across the full width of the transfer duct as it is fed to the rotor.





POWERMATIC PLUS

Loading rotor



Smooth running and fuel saving

POWERMATIC PLUS is the heart of JUMBO series loader wagons. Rugged, powerful and designed for virtually unlimited tractor power, this rotor delivers high throughput, chopping and compression. POWERMATIC PLUS stands for smooth, power-saving penetration of the crop and perfect transfer from the pick-up.

- The loading rotor has eight rows of tines arranged in a spiral and a diameter of 31.49" / 800 mm.
- The loading rotor is mounted on self-aligning ball bearings at both ends.
- The shaft diameter is 3.93" / 100 mm on the drive side end.
- The bearing is located on the rotor frame between the rotor and transmission to protect the bearings and transmission.

Optimised tine geometry

Wide surfaces on the tine points ensure maximum performance even with wet and short forage. The optimised tine shape and large scraper surface ensure the best possible compression in the loading chamber. The conveyor tines are made of hardened fine-grain Durostat 19.68" / 500 and are 0.47" / 12 mm thick. The tine rings are hooked into the central drum and welded around the circumference for exact positioning.

The scrapers have an 0.70" / 18 mm wide rear face and are individually mounted and bolted. They ensure highest possible compression, depending on how the automatic loading system is set.

Unique chopping system



EASY MOVE folding knife bank system

This unique folding knife bank makes light work of changing the knives.

The chopping system is hinged out hydraulically, a process that can be activated from the driver's seat to clear blockages when necessary. The knife bank can be conveniently folded out alongside the wagon.



The knife retention springs and tilting levers are recessed safely out of the way. This greatly reduces the contamination of the knife holders. The spaces between the knives are cleaned by a short material deflector every time the knife bank is hinged outwards.

34 mm knife spacing

The long arc of the knives ensures a slicing cut along the full length of the knife edge. The forage is cut right through exactly and uniformly. The chopped material is ideally structured for ruminants. An optimum gap between the knives and tines ensures smooth operation and protects the knives from foreign objects.





Solid quality

No tools are needed to replace the knives: they are disengaged automatically by a central release mechanism. The knives are produced from hardened tool steel and their pressed serrated blade ensures a precise cut. The extra thick rear edge of the knife guarantees an extended service life.

Extra strong DURASTAR knives for stony soil.

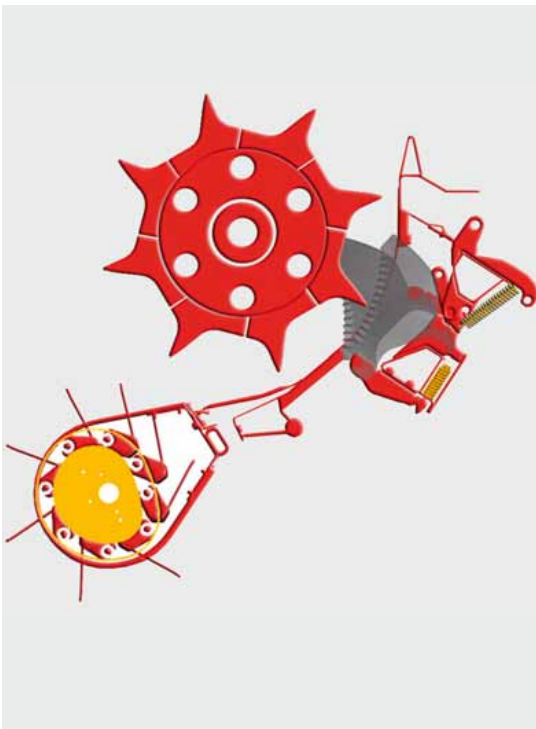

Ensuring knife protection

PÖTTINGER protects the heart of the loader wagon with a patented individual knife protection system. Foreign bodies are a danger to the rotor and chopping system plus downtime can be expensive.

The triggering force is adapted to the high throughput capacity. The knives are held securely in the correct position to make sure that a consistent chop length is produced.

Patented trigger mechanism

- Larger foreign objects only move the knife briefly in the direction of crop flow.
- The triggering roll is lifted out of the interlock on the back of the knife.
- The resistance of the knife is suddenly reduced so that the knife can allow the foreign object to pass through virtually unobstructed. The sharpness of the knife is retained.
- The knife is automatically brought back into the starting position.

Any stones in the forage are not pulverised like they are in harvesters. The cattle leave them in the trough so that injuries to the digestive system are avoided.

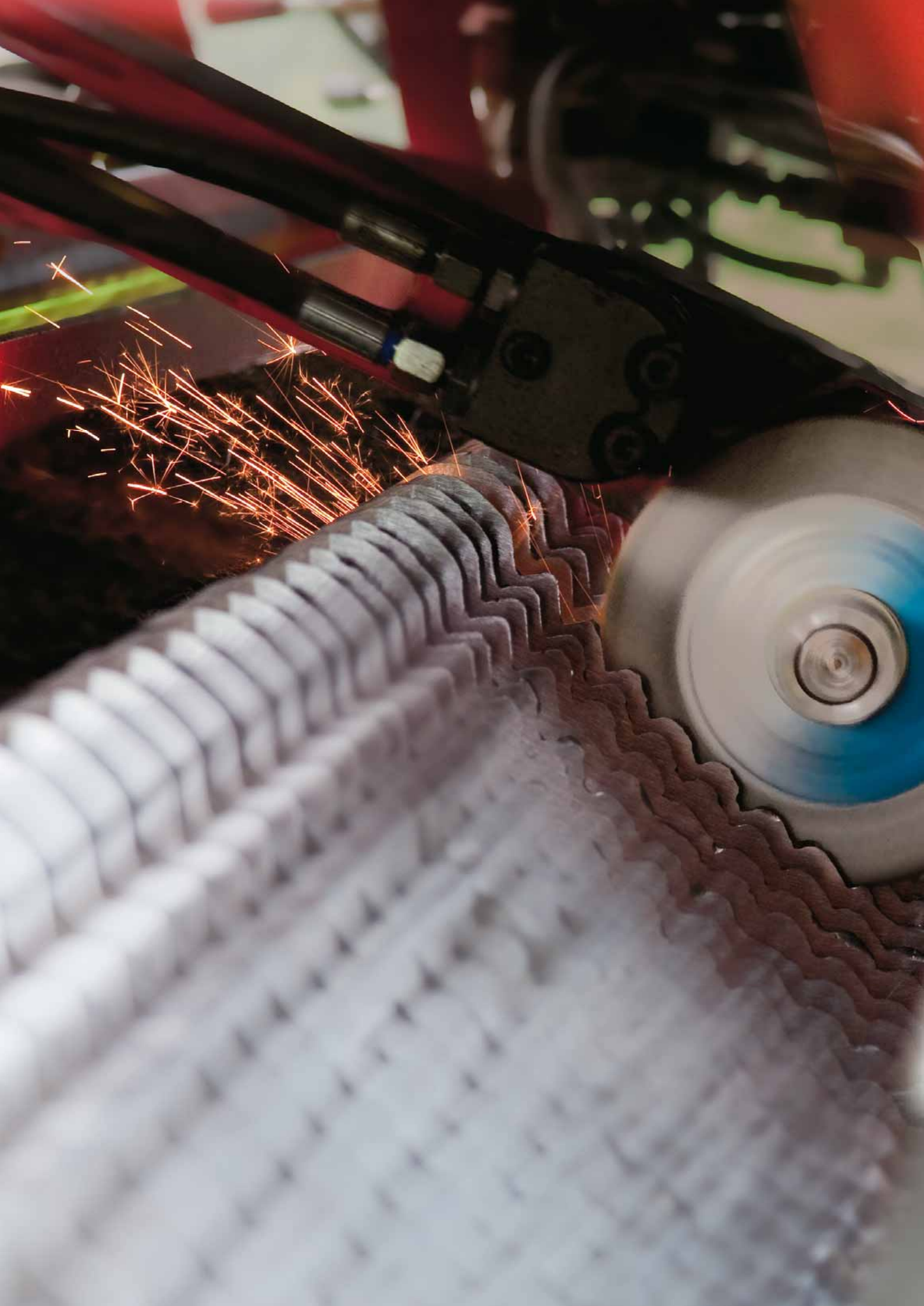

Sharp knives

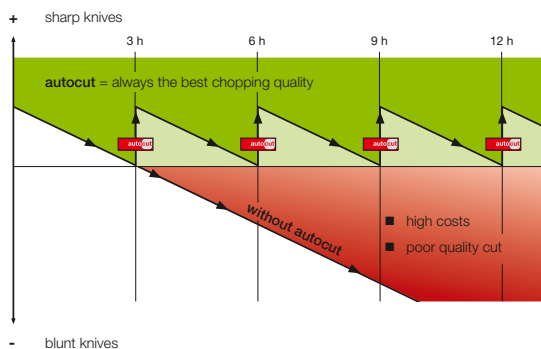

AUTOCUT knife sharpening system

A precise and consistent cut is the basis for the best silage quality. AUTOCUT delivers consistent cutting quality throughout a whole working day.

The AUTOCUT knife sharpening system enables convenient knife sharpening directly on the loader wagon. Depending on the wear of the knives, simply select the sharpening cycle using the operator terminal. This considerably reduces maintenance expenses and at the same time guarantees long-lasting optimal cutting quality with lower energy consumption and increased output.

Consistent chop length

The crop is chopped in precisely the same way again and again, and is not squashed.

15% lower power requirement

- Reduces diesel consumption by 1.09 gal / 5 litres per hour on average
- Increases performance capacity
- Greater economic savings

Much lower maintenance requirement

- Fully automatic sharpening of the complete set of knives at approx. 4 minutes per cycle
- Reduces of maintenance workload by approx. 45 minutes per day.

Your advantages:

- The short material deflector cleans between the knives when they fold out
- Optimised grinding wheel sharpens even contaminated knives
- Adjustable sharpening angle
- Sharpening level can be adjusted if required using pressure regulator
- Fully automatic sharpening of the complete set of knives
- Sharpening cycle takes around four minutes
- Knives always sharp for best chopping quality
- Considerable reduction in maintenance

COMBILINE multifunctional



3-function front flap

Professional farms are looking for maximum versatility and increased machine utilization. The 3-function front flap is operated hydraulically and enables the wagon to be converted in seconds from the comfort of the tractor seat. As a result the JUMBO COMBILINE can quickly change from a silage wagon into a harvest transport wagon, yet again increasing its cost effectiveness.



Loader wagon mode

The wide forage compression flap controls the automatic loading system. The sensor switches the scraper floor on and off automatically. This protects the forage and ensures the loading chamber is filled right up.



Harvest transport mode

The front flap is folded forwards and provides a good view into the loading chamber from the tractor. Ideal for following the harvester into maize. To make full use of the loading chamber, the front flap is raised and the forage compression flap is lowered inwards.



Engineered bodywork

The steel profile panels are fully enclosed, right to the top. The heavy duty construction is designed for the heaviest loads. The profiled plates have a special coating to guarantee a long service life. No extension bars or roof ropes are needed because the side walls extend beyond the forage compression flap. The large surface area of the forage compression flap ensures best compression of the crop and maximum use of the loading chamber.

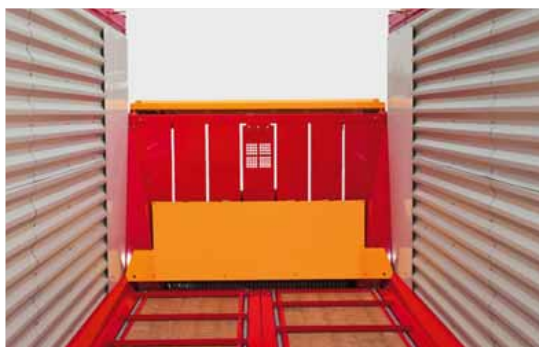

Folding rotor duct cover

The optional duct cover prevents crop from falling into the rotor duct while the wagon is being used for transport. On PÖTTINGER wagons the duct cover simply folds away without any modifications required.



Slanting fenders

All JUMBO COMBILINE wagons are fitted with angled mudguards and closed frame beams. Nothing is left lying on the mudguards. No crop falls onto the road during transport.

Loading



Automatic loading system as standard

The automatic loading system guarantees that the wagon is filled right up to achieve maximum transport capacity. The forage is already carefully compressed in the transfer duct to make full use of the loading chamber.

Two sensors are fitted to monitor the loading sequence by continuously measuring the filling level. Two sensors automatically control the scraper floor to take the pressure off the driver. This also protects the wagon and the crop.



Sensors mounted in front flap and upper panel section

A sensor at the lower end of the front panel measures the loading pressure for damp, heavy grass and switches the scraper floor on and off accordingly. This prevents disintegration of the forage as a result of too high pressure at the loading rotor.

The second sensor in the forage compression flap measures the compression inside the loading chamber. The forage is compressed uniformly and the loading chamber filled to the ideal maximum capacity.



Level sensor on JUMBO COMBILINE

Available as an option, this sensor on the tailgate measures the level inside the loading chamber. The filling level is indicated to the driver as a % value on the control terminal.



The scraper floor

The PÖTTINGER scraper floor guarantees reliability for many years. The hardened bars are offset and easily accessible. The greasing points for the scraper floor shafts are located on the side of the wagon. Unloading speeds of up to 24 metres/min are possible.

4 scraper floor chains, 1 scraper floor gearbox:

JUMBO 6010 / 6610 / 7210 / 8010
 JUMBO COMBILINE 6010 / 6610



6 scraper floor chains, 2 scraper floor gearboxes:

JUMBO 10010
 JUMBO COMBILINE 7210 / 10010



Load sensing

All PÖTTINGER silage wagons are load-sensing compatible. The required oil flowrate is precisely measured and adjusted to demand. This prevents the oil from heating up and saves power by up to 20 hp (15 kW).

ISOBUS version

A load cell on the rotor transmission measures the drive torque and can be precisely adjusted to the type of crop. During loading the loading torque sensor on the transmission controls the scraper floor to deliver complete forage protection without leaving the tractor sear.

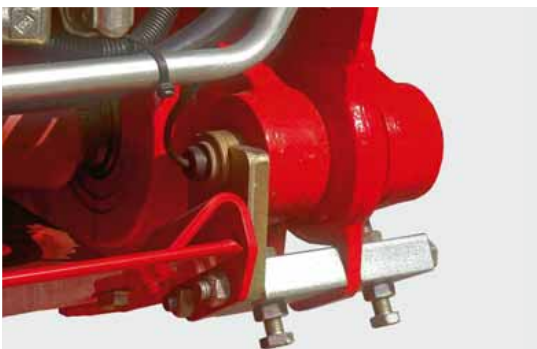

Unloading



Unload at the press of a button

The automatic unloading system makes life easier for the driver and protects the machine. A press of a button on the terminal is all that is needed and the full cross section of the tailgate opens to unload in a few minutes.

On all models, the tailgate opening angle can be adjusted as required from the tractor seat. The effects of crosswinds are minimised as a result.



Metering on demand JUMBO D models

A uniformly distributed blanket of forage is essential for perfect compaction. The beater rotors on JUMOBO D models guarantee's perfect distribution. The aggressive tines deliver an impressive performance even with highly compressed forage. Bars on the rotors ensure maize material can be unloaded effectively. A pressure sensor in the beater rotor bearings controls the scraper floor automatically. A third beater is available as an option for even better distribution.

- Beater drives protected at 1500 Nm
- Automatic chain tensioner
- Easily accessible, central lubrication points





COVER PLUS load containment system

PÖTTINGER offers as an option an automatic load containment system for the JUMBO COMBILINE.

This covers light crop material with a tarpaulin so that nothing is lost during road transport – especially interesting for biogas plants. PÖTTINGER is one step ahead in covering future legal issues here, as legislators are already discussing legal requirements for the safe containment of agricultural materials.

The controls for the load containment system is conveniently integrated into the POWER CONTROL terminal and operates completely automatically. This solution – which has been developed especially for loader wagons – features a hydraulic interlock that enables high travelling speeds. Operator errors are eliminated by integrated sensors.

- Unique solution to completely cover loading chamber, even if filled above 13.12" / 4 m.
- Automatic opening and closing of the tarpaulin controlled from tractor cab.
- Control system integrated into POWER CONTROL terminal.
- No additional hoses and cables inside the cab.

HARDCOVER

New, optional roof profiles for JUMBO COMBILINE.

- For high compression even with low density harvest material.
- Highest capacity load with straw and maize straw.

Chassis

Axles for enhanced safety

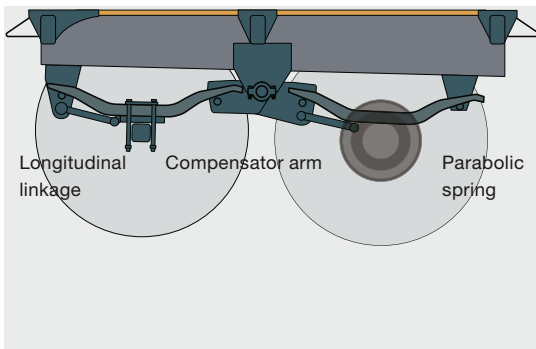

Parabolic spring chassis

The compensator arm ensures dynamic equalisation during braking so the same load acts on each wheel. At the same time you are guaranteed perfect suspension characteristics in the clamp and smooth running in the field and on the road. Shock absorber struts are supplied as standard for best driving performance at high speed.

- Large spring clearance at front (43.30" / 1100 mm) and rear (33.70" / 856 mm).
- Rugged longitudinal linkages absorb braking forces and control axle guidance.
- BPW axles with 16.14" x 4.72" / 410 x 120 mm brake pads for powerful braking at high transport speeds.
- Trailing steered axle protects the sward even with heavy loads. (Standard)
- Trailing steered axle is standard.
- Steered axles and EBS brakes available as option.

Parabolic spring chassis 22.5" / 26.5" up to total weight of 22 t

This chassis together with 22.5" tyres offers a very low centre of gravity of gravity, especially for working on slopes. With 26.5" tyres the chassis offers even lower rolling resistance in difficult conditions and in the clamp.

Parabolic spring chassis for 26.5" tyres with stabiliser strut up to total weight of 48500 lbs / 22 t

The advantage of the reinforced parabolic leaf springs (52910 lbs / 24 t) with additional stabiliser strut is improved driving performance on slopes and corners. (20% higher driving stability)



Hydro-pneumatic chassis

The hydro-pneumatic chassis offer a wider wheel spacing of 42.7" / 1085 mm for safe driving characteristics in all situations. Even with 26.5" tyres, this chassis offers excellent performance on slopes thanks to enhanced stability. The large axle compensation of up to 10.6" / 270 mm is designed to handle challenging field entrances and poor track conditions.

- Standard spring version, mechanically lockable
- Highest level of driving comfort in traffic and off-road.
- Optimum braking power thanks to equal axle load distribution.
- Steered axles and EBS brakes (optional).
- Central lubrication system (optional).

Weighing system

The optional weighing system with management software and data saving module weighs and records each load. Hydro-pneumatic chassis and ISOBUS are required.

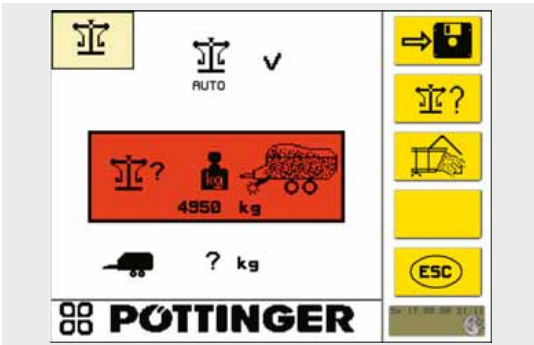

Performance hydropneumatic chassis

Best driving comfort available



Tandem chassis

with hydro-pneumatic suspension up to a total weight of 52910 lbs / 24 t

Perfect suspension characteristics in the clamp – smooth running in the field and on the road. Robust longitudinal links absorb braking forces and control axle guidance.

- Axles with 16.14" x7,08" / 410 x 180 mm brake pads.
- Trailing steered axle as standard,
- hydraulic or electro-hydraulic steered axles (optional).
- EBS braking system (optional).



Tridem chassis

with steered axles up to a total weight of 38342 lbs / 31 t

The PÖTTINGER Tridem chassis distributes heavy loads over a large surface area to minimise pressure transmitted to the ground. The large axle equalisation ensures a uniform distribution of effective braking force to all axles. At the same time the wagon follows precisely in the tractor's tracks on slopes and in the clamp.

Lifting axle on tridem chassis

The lifting axle is available as an equipment option to minimise wear to the tyres when the wagon is empty.





Even more safety on the move

EBS – Electronic Braking System

The optional electronic braking system adds another level of safety to braking. It prevents the wheels from blocking when braking on smooth road surfaces and stops the wagon from skidding. The driver can keep the vehicle under control much more easily.

RSP – Roll Stability Program for agricultural vehicles

While steering or manoeuvring at high speed with a full load or high centre of gravity, there is an increased risk of tipping over. This system detects critical situations by monitoring the lateral acceleration, load weight and driving speed. Automatic braking of individual wheels reduces the speed as well as the lateral acceleration. Driving stability is restored automatically.

Central lubrication system for axles with hydro-pneumatic suspension

All greasing points on the vehicle are grouped together and routed out to an accessible position on the lower edge of the wagon frame beam. Standard on chassis with EBS braking system.

Automatic central lubrication system

An automatic central lubrication system for all greasing points is also available as an option.

- Easy servicing
- Always ready for action



Chassis Tyres



Have a safe journey

Increasing load volumes and high transport speeds necessitate a robust chassis that protects the ground. PÖTTINGER has invested a great deal in this issue. High quality tandem and tridem axles with tyres that provide a large surface area of ground contact are the answer.

Thanks to the automatic transport position as standard, the wagon is always horizontal while on the move.

	JUMBO			
	6610 L / D	7210 L / D	8010 L	10010 L
High drawbar 2.2 sh t / 2 t supported load	■	■	■	–
Low drawbar 2.2 sh t / 2 t supported load	□	□	□	–
Low drawbar 3.3 sh t / 3 t supported load	□	□	□	–
Low drawbar 4.4 sh t / 4 t supported load	□	□	□	■
Parabolic spring chassis	■	■	■	–
Parabolic spring chassis with stabiliser strut	□	□	□	–
Tandem chassis with hydro-pneumatic suspension	□	□	□	–
Tridem chassis with hydro-pneumatic suspension	–	□	□	■
Hydraulic steered axles with K50 ball coupling	□	□	□	■
Electro-hydraulic steered axles*	□	□	□	□
K80 ball coupling	□	□	□	■
Lifting axle for tridem axles	–	□	□	□
Central lubrication system for hydro-pneumatic chassis	□	□	□	□
Air brakes	■	■	■	■
Air brakes with EBS and RSP	□	□	□	□
Hydraulic brakes	□	□	□	□
Emergency brake valve for hydraulic brakes, mechanical	□	□	□	□
Tyres 600/50 R 22.5	■	■	■	–
Tyres 710/45 R 22.5	□	□	□	■
Tyres 710/50 R 26.5	□	□	□	□
Tyres 750/45 R 26.5	□	□	□	□
Tyres 800/45 R 26.5	□	□	□	□

■ = standard, □ = optional, *only for hydro-pneumatic chassis 26.5" with air brakes



**Nokian
Country King**



**Vredestein
FLOTATION TRAC**



**Vredestein
FLOTATION PRO**



JUMBO COMBILINE

JUMBO COMBILINE			Permissible overall weight		
6610 L / D	7210 L / D	10010 L / D	2.2 sh t / 2 t drawbar	3.3 sh t / 3 t drawbar	4.4 sh t / 4 t drawbar
-	-	-			
-	-	-			
■	■	-			
□	□	■			
-	-	-	22 sh t / 20 t	23.1 sh t / 21 t	24.2 sh t / 22 t
■	-	-	22 sh t / 20 t	23.1 sh t / 21 t	24.2 sh t / 22 t
□	■	-	24.2 sh t / 22 t	25.3 sh t / 23 t	26.5 sh t / 24 t
-	□	■	-	33.1 sh t / 30 t	34.2 sh t / 31 t
□	□	■			
□	□	□			
□	□	■			
-	□	□			
□	□	□			
■	■	■			
□	□	□			
□	□	□			
□	□	□			
-	-	-			
■	■	■			
□	□	□			
□	□	□			
□	□	□			



Terminals

Exceptional comfort



POWER CONTROL Terminal

All functions are controlled directly from the terminal. Error messages are also displayed. Data acquisition is integrated.

- Automatic functions for loading and unloading
- Ergonomic layout of control keys
- Back-lit keys



POWER CONTROL Wireless

For convenient operation of the loader wagon, including from outside the tractor cab.

- A carry-belt keeps both hands free
- Wide range of up to 328" / 100 m



CCI 100 Terminal – 100 % ISOBUS

High-end operating convenience as an option. This operator terminal lets you control ISOBUS machines from different manufacturers.

- High quality 8.4" TFT colour screen with back-lit keys
- Touch screen with 12 soft keys
- USB interface, M 12x1 camera connection
- Loading rotor torque measurement for controlling automatic loading by quick and accurate adjustment to changing forage conditions from the driver's seat.
- Speed-dependent control of steered axle
- Weighing system

Technical data



JUMBO	6610 L	6610 D	7210 L	7210 D	8010 L	10010 L
Load capacity cu ft / m ³	2330 / 66	2330 / 66	2542 / 72	2542 / 72	2824 / 80	3530 / 100
DIN volume cu ft / m ³	1377 / 39	1341 / 38	1500 / 42.5	1435 / 41.5	1641 / 46.5	1747 / 49.5
Pick-up width ft / m	6.56 / 2.0	6.56 / 2.0	6.56 / 2.0	6.56 / 2.0	6.56 / 2.0	6.56 / 2.0
SUPERLARGE pick-up ft / m	7.74 / 2.36	7.74 / 2.36	7.74 / 2.36	7.74 / 2.36	7.74 / 2.36	7.74 / 2.36
Number of knives	45	45	45	45	45	45
Knife spacing inch / mm	1.33 / 34	1.33 / 34	1.33 / 34	1.33 / 34	1.33 / 34	1.33 / 34
Loading area length ft / m	25.42 / 7.75	22.63 / 6.90	25.68 / 7.83	24.86 / 7.58	27.95 / 8.52	31.10 / 9.48
Loading area width ft / m	7.54 / 2.30	7.54 / 2.30	7.54 / 2.30	7.54 / 2.30	7.54 / 2.30	7.54 / 2.30
Length ft / m	32.57 / 9.93	34.12 / 10.40	34.77 / 10.60	33.03 / 11.07	37.36 / 11.39	39.33 / 11.99
Width ft / m	8.36 / 2.55	8.36 / 2.55	8.36 / 2.55	8.36 / 2.55	8.36 / 2.55	9.02 / 2.75
High 22.5" tyres ft / m	13.05 / 3.98	13.05 / 3.98	13.05 / 3.98	13.05 / 3.98	13.05 / 3.98	13.05 / 3.98
High 26.5" tyres ft / m	13.05 / 3.98	13.05 / 3.98	13.05 / 3.98	13.05 / 3.98	13.05 / 3.98	13.05 / 3.98
Platform height 22.5" ft / m	4.79 / 1.46	4.79 / 1.46	4.79 / 1.46	4.79 / 1.46	4.79 / 1.46	4.79 / 1.46
Platform height 26.5" ft / m	5.18 / 1.58	5.18 / 1.58	5.18 / 1.58	5.18 / 1.58	5.18 / 1.58	5.49 / 1.675
Standard weight sh t / t	9.65 / 8.75	10.14 / 9.2	9.92 / 9.0	10.42 / 9.45	10.20 / 9.25	12.95 / 11.75
Permissible laden weight sh t / t	22 / 20	22 / 20	22 / 20	22 / 20	22 / 20	34.2 / 31
Maximum total weight sh t / t	26.5 / 24	26.5 / 24	34.2 / 31	34.2 / 31	34.2 / 31	34.2 / 31



6610 L COMBILINE	6610 D COMBILINE	7210 L COMBILINE	7210 D COMBILINE	10010 L COMBILINE	10010 D COMBILINE
2330 / 66	2330 / 66	2542 / 72	2542 / 72	3530 / 100	3530 / 100
1338 / 37.9	1288 / 36.5	1465 / 41.5	1415 / 40.1	1698 / 48,1	1645 / 46.6
6.56 / 2.0	6.56 / 2.0	6.56 / 2.0	6.56 / 2.0	6.56 / 2.0	6.56 / 2.0
7.74 / 2.36	7.74 / 2.36	7.74 / 2.36	7.74 / 2.36	7.74 / 2.36	7.74 / 2.36
45	45	45	45	45	45
1.33 / 34	1.33 / 34	1.33 / 34	1.33 / 34	1.33 / 34	1.33 / 34
20.50 / 7.20	22.73 / 6.93	25.85 / 7.88	24.96 / 7.610	30.28 / 9.230	29.03 / 8.85
7.54 / 2.30	7.54 / 2.30	7.54 / 2.30	7.54 / 2.30	7.54 / 2.30	7.54 / 2.30
32.57 / 9.93	32.57 / 9.93	34.80 / 10.61	34.80 / 10.61	38.91 / 11.86	38.91 / 11.86
9.58 / 2.92	9.58 / 2.92	9.74 / 2.97	9.74 / 2.97	9.25 / 2.82	9.25 / 2.82
12.56 / 3.83	12.56 / 3.83	12.68 / 3.865	12.68 / 3.865	12.45 / 3.795	12.45 / 3.795
12.94 / 3.945	12.94 / 3.945	13.09 / 3.99	13.09 / 3.99	13.09 / 3.99	13.09 / 3.99
5.00 / 1.525	5.00 / 1.525	5.09 / 1.55	5.09 / 1.55	4.86 / 1.48	4.86 / 1.48
5.38 / 1.64	5.38 / 1.64	5.49 / 1.675	5.49 / 1.675	5.49 / 1.675	5.49 / 1.675
10.09 / 9.15	10.69 / 9.7	11.68 / 10.6	12.29 / 11.15	13.17 / 11.95	13.78 / 12.5
23.1 / 21	23.1 / 21	25.4 / 23	25.4 / 23	34.2 / 31	34.2 / 31
26.5 / 24	26.5 / 24	34.2 / 31	34.2 / 31	34.2 / 31	34.2 / 31

Equipment options



**WIRELESS
POWER CONTROL**



CCI Terminal ISOBUS



SUPERLARGE pick-up



**Additional pick-up
support roller**

JUMBO L	<input type="checkbox"/>	<input type="checkbox"/>	<input type="checkbox"/>	<input type="checkbox"/>
JUMBO D	<input type="checkbox"/>	<input type="checkbox"/>	<input type="checkbox"/>	<input type="checkbox"/>
JUMBO 10010 L	<input type="checkbox"/>	<input type="checkbox"/>	<input type="checkbox"/>	<input type="checkbox"/>
JUMBO COMBILINE L	<input type="checkbox"/>	<input type="checkbox"/>	<input type="checkbox"/>	<input type="checkbox"/>
JUMBO COMBILINE D	<input type="checkbox"/>	<input type="checkbox"/>	<input type="checkbox"/>	<input type="checkbox"/>



Roof profiles



Folding cover for duct



3rd beater rotor



**2-speed scraper floor
drive**

JUMBO L	<input type="checkbox"/> / <input checked="" type="checkbox"/> 8010 L	–	–	<input type="checkbox"/>
JUMBO D	<input type="checkbox"/>	–	<input type="checkbox"/>	<input type="checkbox"/>
JUMBO 10010 L	<input checked="" type="checkbox"/>	–	–	<input checked="" type="checkbox"/>
JUMBO COMBILINE L	<input type="checkbox"/> / – 6610	<input type="checkbox"/>	–	<input checked="" type="checkbox"/>
JUMBO COMBILINE D	<input type="checkbox"/> / – 6610	<input type="checkbox"/>	<input type="checkbox"/>	<input checked="" type="checkbox"/>

■ = Standard, □ = Optional

More equipment options

LARGE tailgate

Extension plate for LARGE tailgate

LED floodlight

Beacon light for loader wagon

Central lubrication system



Hydraulic pick-up weight alleviation

-
-
-
-
-

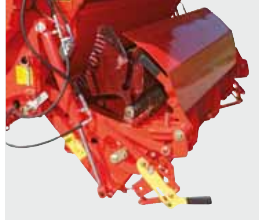

Cleaning comb for knives

-
-
-
-
-



AUTOCUT knife sharpening system

-
-
-
-
-



Loading rotor torque control

-
-
-
-
-

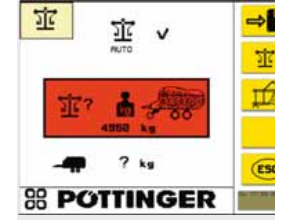

Weighing system

-
-
-
-
-

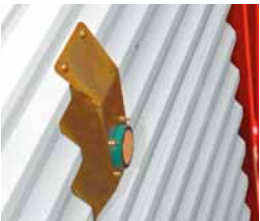

Level sensor

-
-
-
-
-



COVER PLUS load containment system

-
-
-
-
-



LED floodlight

-
-
-
-
-



Video system with one camera

-
-
-
-
-



Demarcation lights

-
-
-
-
-



PÖTTPRO

Your machine goes online.

All the information on your machine
easily – anytime – anywhere

Simply scan the QR code on the **data plate** with your smartphone or tablet or enter your machine number at www.poettinger.at/poetpro. You will immediately receive all the information on your machine.

- Operating instructions
- Optional equipment information
- Brochures
- Photos and videos



Original *inside* **24** hours service

PÖTTINGER Spare parts service

- Worldwide network of sales and service partners.
- Decades of spare and wear parts availability.
- Original PÖTTINGER parts can be ordered online around the clock.

**Alois PÖTTINGER
Maschinenfabrik GmbH**
Industriegelände 1
4710 Grieskirchen
Austria
Phone +43 7248 600-0
Fax +43 7248 600-2511
info@poettinger.at
www.poettinger.at

Alois PÖTTINGER UK Ltd.
15 St Marks Road, Corby
Northamptonshire,
NN18 8AN
United Kingdom
Phone +44 1536 272 220
info.uk@pottingeruk.co.uk
www.pottingeruk.co.uk

PÖTTINGER Canada Inc.
650, Route 112
St-Cesaire, PQ J0L 1T0
Canada
Phone +1 450 469 5594
Fax +1 866 417 1683
sales.canada@poettinger.ca
www.poettinger.ca

PÖTTINGER US, Inc.
393 Pilot Drive
Valparaiso, IN 46383
USA
Phone +1 219 510-5534
Fax + 1 219 707-5412
sales.us@poettinger.us
www.poettinger.us

PÖTTINGER Australia PTY LTD
15 Fordson Road
Campbellfield, VIC 3061
Australia
Phone +61 3 9359 2969
sales.au@poettinger.com.au
www.poettinger.com.au

PÖTTINGER Ireland Ltd.
Industrial Estate
Cashel Rd., Clonmel, Co. Tipperary
Ireland
Phone +353 52 6125766
info.ie@poettinger.at
www.poettinger.ie

**Importer for New Zealand:
Origin Agroup**
PO Box 673, 57 Hautapu Road
Cambridge
New Zealand
Phone +64 7 823 7582
info@originagroup.co.nz
www.originagroup.co.nz

**Importer for South Africa:
VALTRAC**
Cnr. Water & Buiten Street
9585 Parys
South Africa
Phone +27 56 817 7338 7308
wynn@valtrac.co.za
www.valtrac.co.za

