

CARGO DIGGER PLANT2

EARTH MOVING

BRIAN JAMES TRAILERS

» Connected to you



UNITED KINGDOM

CARGO DIGGER PLANT 2



CARGO DIGGER PLANT2 EARTH MOVING

***5** 5 YEAR
EXTENDED
WARRANTY



The innovative **CarGO Digger Plant2** range provides a modern, advanced and compliant transport solution for many tracked excavators and plant machines such as chippers and shredders. With obvious appeal to larger organisations, the ideas pioneered in the **CarGO Digger Plant2** also translate to smaller fleets and individual users interested in efficiency and safety.

Being a part of the Brian James Trailers range, **CarGO Digger Plant2** features a low ride height for optimal distribution of weight and stable towing performance.

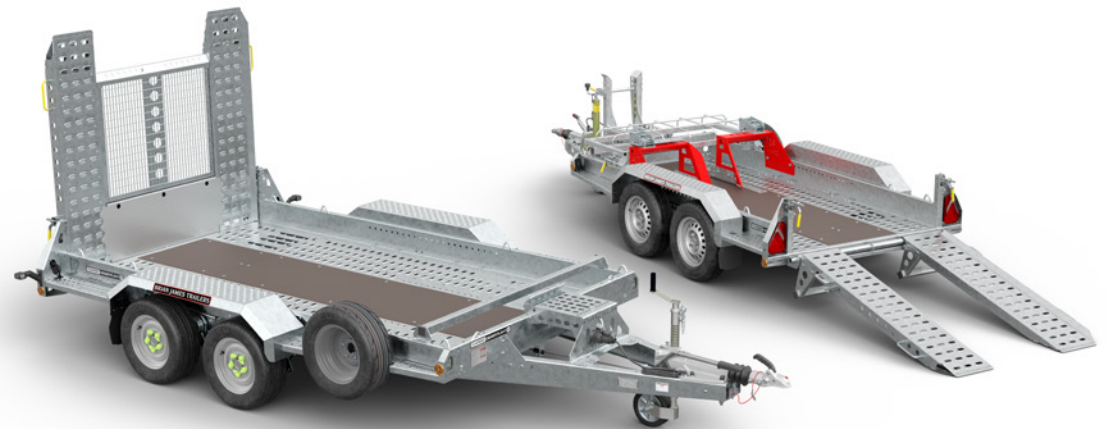

* 1 year warranty as standard. Additional 4 year warranty period requires product registration.

CARGO DIGGER PLANT 2

STANDARD FEATURES

Highest capacity

CarGO Digger Plant2 has a gross capacity of 2,700kg or 3,500kg. It combines this with class leading light, but tough chassis design to achieve unrivalled payload capability. Whether moving diggers or dumpers our advanced low chassis design and versatile layout, achieves recommended weight distribution, ensuring stable and safe towing.

The deck design is constructed using heavy duty phenol ply (18mm), with substantial under deck chassis reinforcements. Even the heaviest machinery such as road rollers or mini diggers will not cause damage. Robust steel mudguards and all around high-grip side steps provide easy and safe access to machinery on the trailer.



- **Long drawbar** provides plenty of space for digger arms.
- **Jockey wheel**
Heavy duty jockey wheel. Features anti-vibration latch and is positioned away from conflict with loaded machinery.

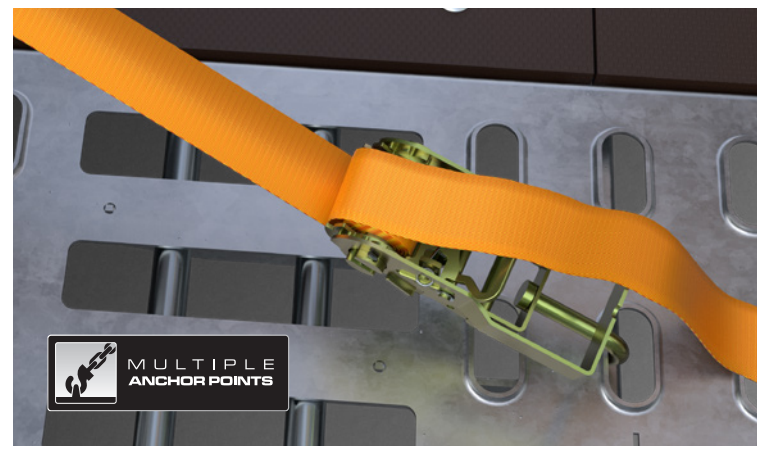

MULTIPLE ANCHOR POINTS

- **Multiple anchor points**
Numerous strap attachment points are provided along each side of Digger Plant2 trailers. Each is located in the chassis providing ultimate strength. A high level of grip and strength is offered by the raised, punched profile of each slot. Machine restraint is made easy with many tie-down options.

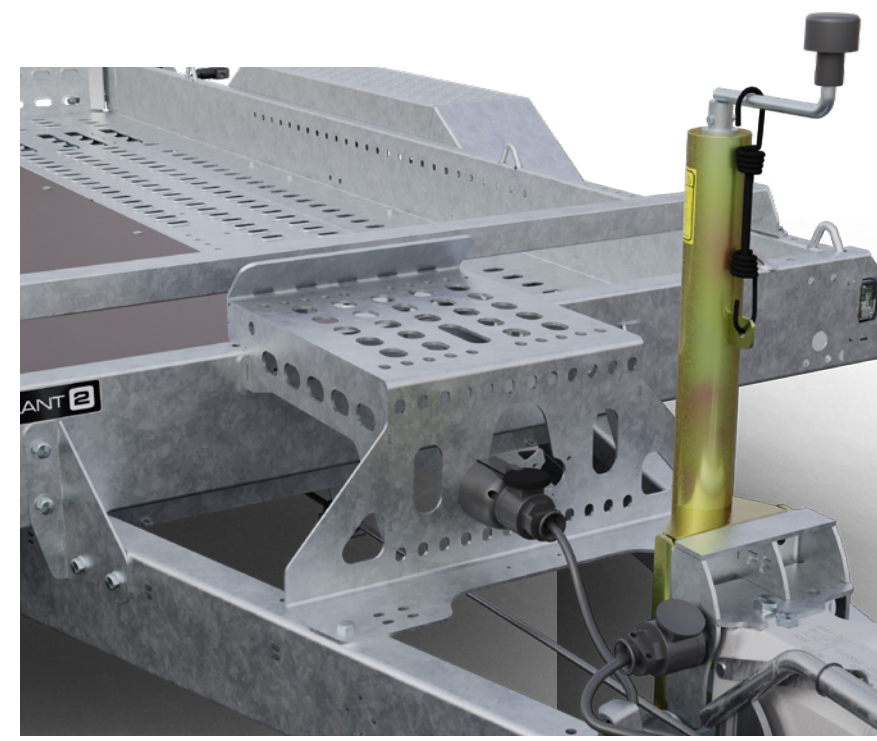
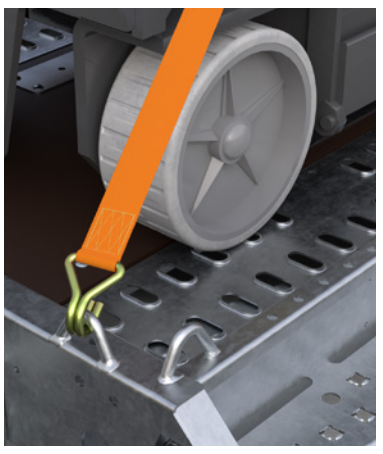

- **Universal bucket rest**
Standard fitment on CarGO Digger Plant2 trailers.



HIGH GRIP SURFACE

- **High grip**
Features high strength punched and formed steel. Provides grip and is extremely resistant to wear, even on tough jobs.

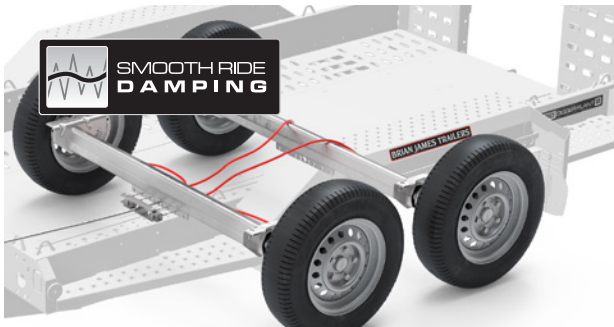

GALVANISED FOR LONG LIFE

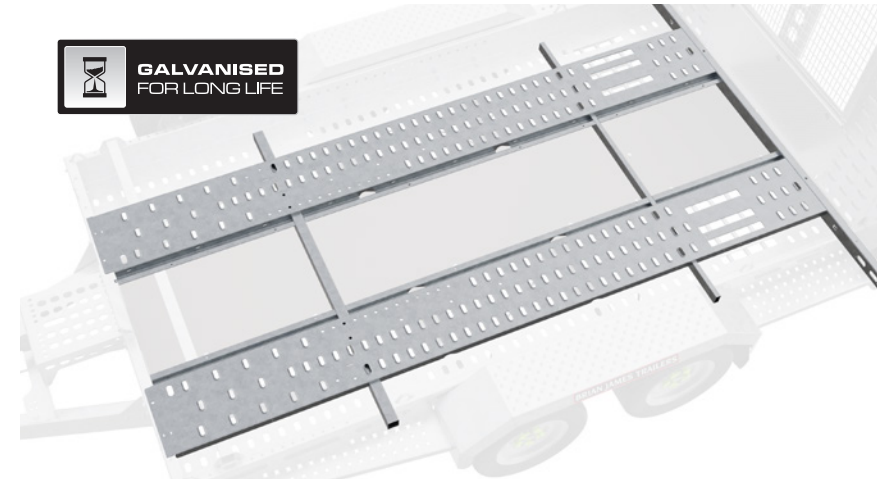

● **ACME thread clamps.** Silent locked – the loading tail ramp is held in place with secure clamp fasteners. A rubber buffer is part of the system and provides damping for quiet travel.



● **Smooth-ride, self damping**

Digger Plant2 trailers are designed for long distance and heavy loads. Axles and suspension technology is proven beyond doubt.

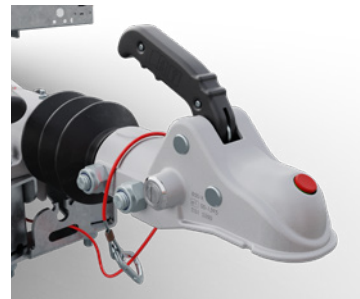

● **50mm ball coupling head** with security lock.

● **Super-Structure**

The strength of Digger Plant2 is more than skin deep. Super-strength steel used in the main chassis fabrication is complemented by two additional longitudinal beams just below the 18mm phenol ply anti-slip centre bed. Lighter weight and improved strength, combined with the durability of a hot-dip galvanised chassis ensures that Digger Plant2 will serve for many years.

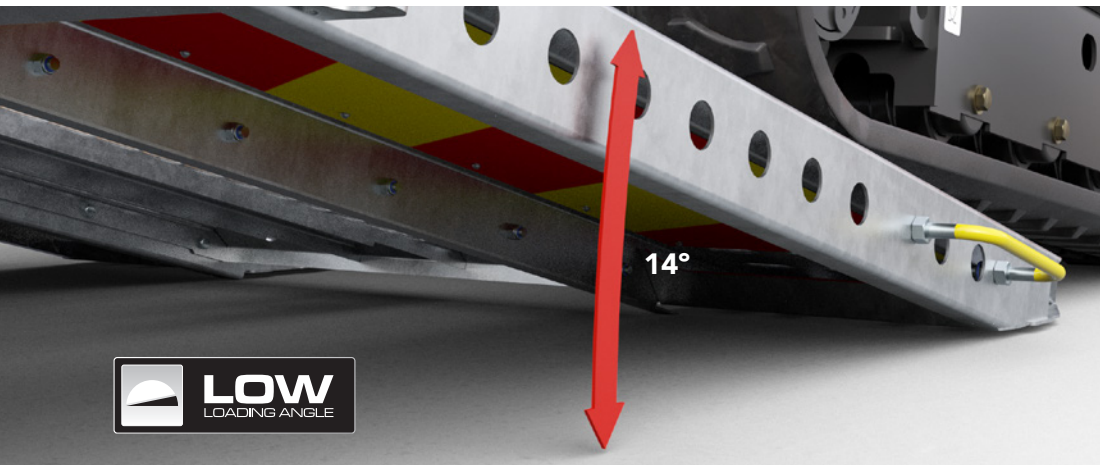

● **Low loading angle**

The Digger Plant2 features a loading angle of 14° which enables easy loading and unloading of machines.

● Standard. ○ Optional at extra cost.

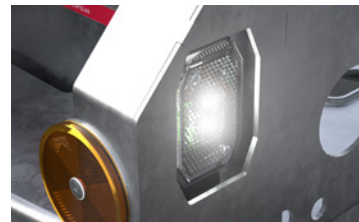

● **High quality lighting system** - both bright and reliable. Digger Plant2 features a high quality stylish combination bulbed lamps that are well protected from accidental damage.

○ **Upgrade to full LED lighting**

Replace bulbed rear lamps with LED technology. Super bright and extremely durable.

LED lamps: Note

LED lamps may not be compatible with all towing vehicles. Please check compatibility. Electronic 'Lighting Control Gear' is available as an option.

OPTIONS

Does the job, better

A full working specification as standard gets the job done. We also know that each operator has differing requirements and have catered for this with an unrivalled range of optional configurations, each available at the time of order, or as a retro-fit.



Chapter 8 Chevrons provide compliance with vehicle marking regulations for sites. (Shown with optional reinforced centre infill mesh panel kit for twin ramp tail panel).

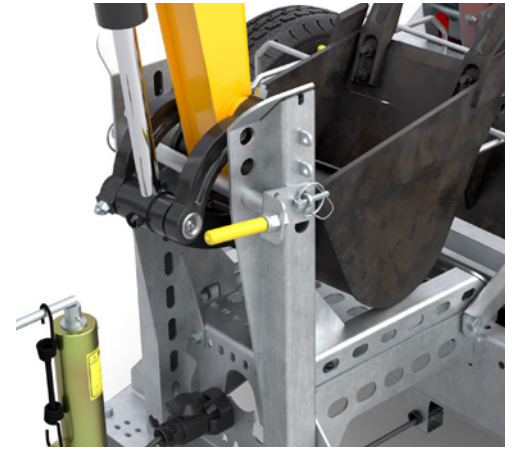

Digger Arm Lock
Guides and secures the digger arm and bucket to the trailer with a single heavy duty locking pin.



Bucket locker
Secure lockable storage for digger buckets and other attachments.



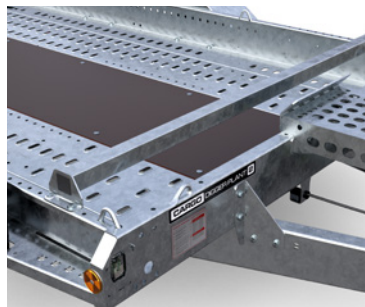

○ **Machine stop bar** designed to provide a reliable stop for digger and plant machinery. Must be used in combination with tie-down restraint straps.

○ **Spare wheel**
Mounted conveniently towards the front of the trailer.

○ **Wheel safety indicators**

Wheel Sentry. Combined wheel nut indicator and retainer.

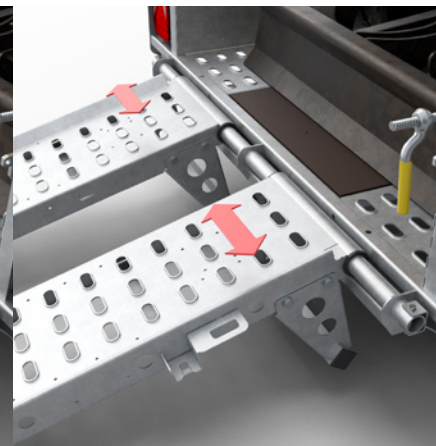

○ **Adjustable punched ramps** provide low loading angle for all types of vehicles. Each ramp can be positioned across the full width in seconds. Constructed from galvanised steel, punched for high grip. Unique nylon hinge sleeves eradicate unwanted rattles and wear.



○ **TracStrap system**

The Tracstrap system is unique to Brian James Trailers and the Digger Plant2. This in-house designed and manufactured system offers extremely high levels of towing security with minimal effort (TÜV Nord test report 8114838799). The front chocks are adjustable and provide a fixed loading point. Each track is held in place by a 10 tonne rated 75mm wide straps (yellow) featuring heavy duty wear protectors (blue).

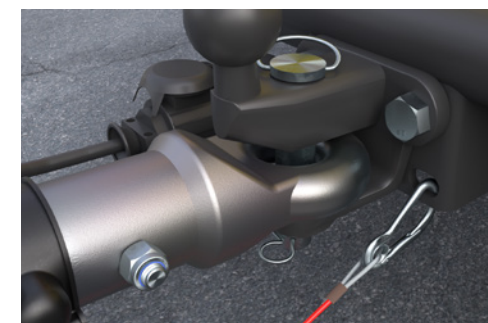

○ **Eye coupling**

40mm. Available for applications in which a pin and eye coupling is required.



CARGO DIGGER PLANT 2

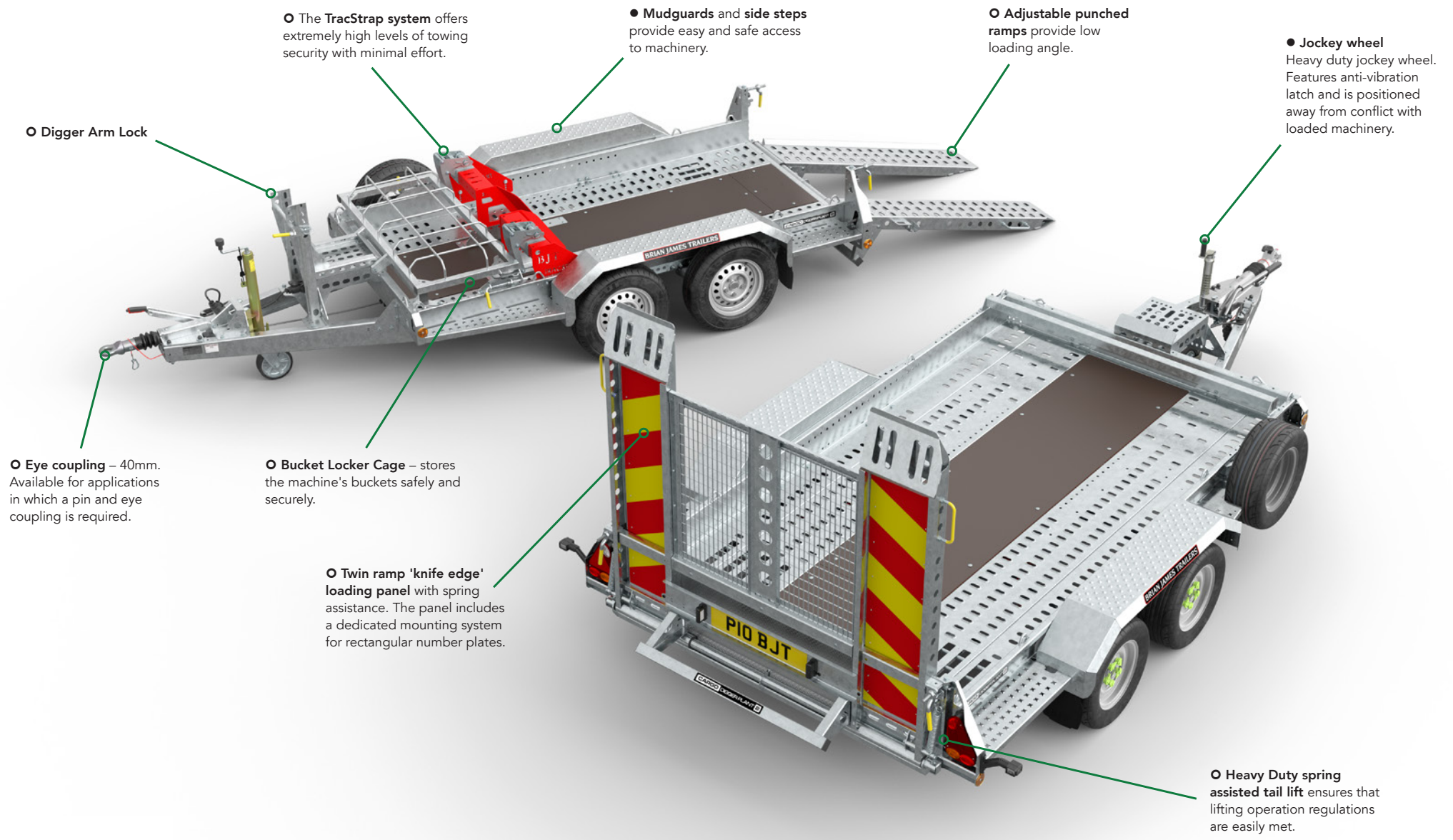

○ The **TracStrap system** offers extremely high levels of towing security with minimal effort.

● **Mudguards and side steps** provide easy and safe access to machinery.

○ **Adjustable punched ramps** provide low loading angle.

● **Jockey wheel**
Heavy duty jockey wheel. Features anti-vibration latch and is positioned away from conflict with loaded machinery.

○ **Digger Arm Lock**

○ **Eye coupling** – 40mm. Available for applications in which a pin and eye coupling is required.

○ **Bucket Locker Cage** – stores the machine's buckets safely and securely.

○ **Twin ramp 'knife edge' loading panel** with spring assistance. The panel includes a dedicated mounting system for rectangular number plates.

○ **Heavy Duty spring assisted tail lift** ensures that lifting operation regulations are easily met.

TECHNICAL INFORMATION

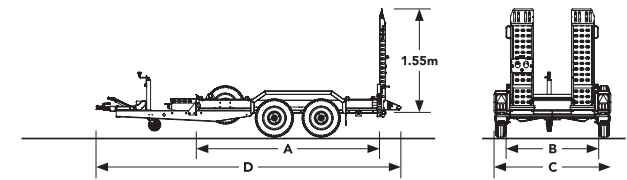

LOAD BED LENGTH m A	2.80	3.20
CAPACITY		
Gross kg	2,700	3,500
Load kg	2,195	2,818
Unladen trailer weight kg	505	682
DIMENSIONS		
Internal bed width m B	1.30	1.70
Overall trailer width m C	1.79	2.32
Overall trailer length m D	4.65	5.12
Bed load height m	0.38	0.40
Towball height (loaded, centre of towball) m	0.40	0.40
Working load angle	14°	14°
RUNNING GEAR		
Axles	2	2
Wheel / Tyre size	13" (165 6pr)	12" (195/60)
Heavy duty jockey wheel	●	●
Locking tow hitch	●	●
STANDARDS / WARRANTY		
Directive 200/46/EC approval	●	●
Galvanised steel - EN ISO 1461	●	●
5 year extended chassis warranty - 1 year warranty as standard. Additional 4 year warranty period requires product registration	●	●
PRODUCTS		
Product code	543-0110	543-1320
REAR LOADING		
Adjustable position "high grip" punched ramps x 2	○	○
Twin ramp "knife edge" loading panel + spring assistance	○	○
Reinforced centre infill mesh panel for twin ramp tail panel	○	○
LIGHTING		
LED rear light upgrade	○	○
LED light control gear	○	○
LOADING, WHEELS AND SECURITY		
Spare wheel	○	○
Bucket locker cage - Store buckets in front of the digger safely	○	○
Machine stop bar - Adjustable full width bar	○	○
TracStrap system - Secure + easy strapping system incorporating track stops	○	○
Digger arm lock - Safe towing aid	○	○
Tie-down anchor points (internal)	Multiple in platform	
Eye coupling - 40mm	○	○
Tie-down straps	○	○
Chapter 8 chevrons - Site regulation compliant vehicle markings	○	○
Wheel nut indicators - Wheel sentry kit	○	○

● Standard ○ Optional at extra cost

CARGO DIGGER PLANT 2

QUALITY

Brian James Trailers are manufacturers of class leading trailers, since 1979. When you buy a Brian James Trailer you can be absolutely certain that it is designed and constructed to the highest possible standards. Our engineers combine top-quality craftsmanship with the best materials and first-class presentation. Light but strong, our trailers are crafted to enhance safety, efficiency and durability.

5 Year Extended Chassis Warranty

This Brian James Trailer is provided to you with a standard 1 year non-transferable manufacturers warranty covering the integrity of the chassis, which can be extended to 5 years upon registration.

We warrant that under normal use, outside of accident damage or misuse (meaning driven across unsuitable territory or being overloaded) the chassis will not fatigue or fail to be able to perform its intended duties safely.

Any repair or rectification as a result of a claim under this warranty will be at Brian James Trailers cost and be carried out either at a Brian James Trailers main dealer, or at the factory HQ in Daventry, UK, at the discretion of Brian James Trailers Ltd. A repair may involve removal of the original galvanised surface finish, for which we will not liable to reinstate to its original state.

Brian James Trailers will not be liable for any consequential loss in connection with a claim on this warranty, including recovery fees or transport to or from the place of final repair.

5 year extended warranty applies to the chassis only. All other components are subject to a standard 1 year warranty, subject to fair wear and tear.

Standards



A graphic with a red square containing a white number '5' on the left, and a black rectangle with the text '5 YEAR EXTENDED WARRANTY' in white on the right.

A dark grey rectangular box with the text 'CARGO DIGGER PLANT2' and 'EARTH MOVING' in white, stacked vertically.



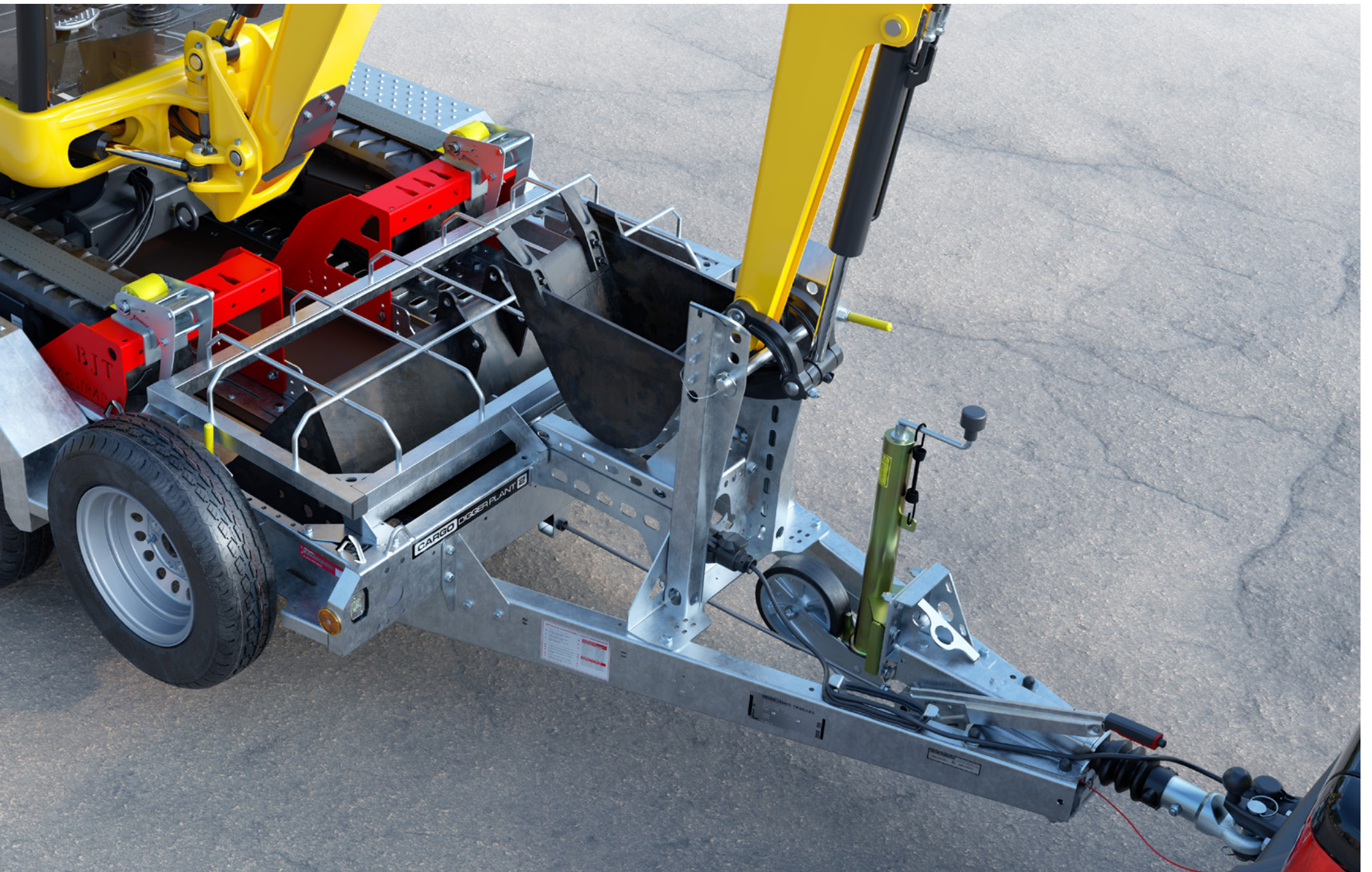

CARGO DIGGER PLANT2

BRIAN JAMES TRAILERS

» Connected to you

NOTES

Specifications are subject to change without notice. Illustrations and photography may depict optional equipment.

www.brianjames.co.uk

© BRIAN JAMES TRAILERS LIMITED

Edition CGDIGPL22020_Q1_1



THE QUEEN'S AWARDS
FOR ENTERPRISE:
INTERNATIONAL TRADE
2018

Brian James Trailers Limited.

Sopwith Way, Drayton Fields Industrial Estate
Daventry, Northampton, NN11 8PB

T + 44 (0)1327 308 833

Brian James Trailers are available by contacting our sales team as well as through an extensive network of official dealers throughout the country.

For more information please call or visit our website.

www.brianjames.co.uk

Dealer information

